

Capri Trousers

Project design © Love Productions 2015
This design is protected by copyright and
must not be made for resale.

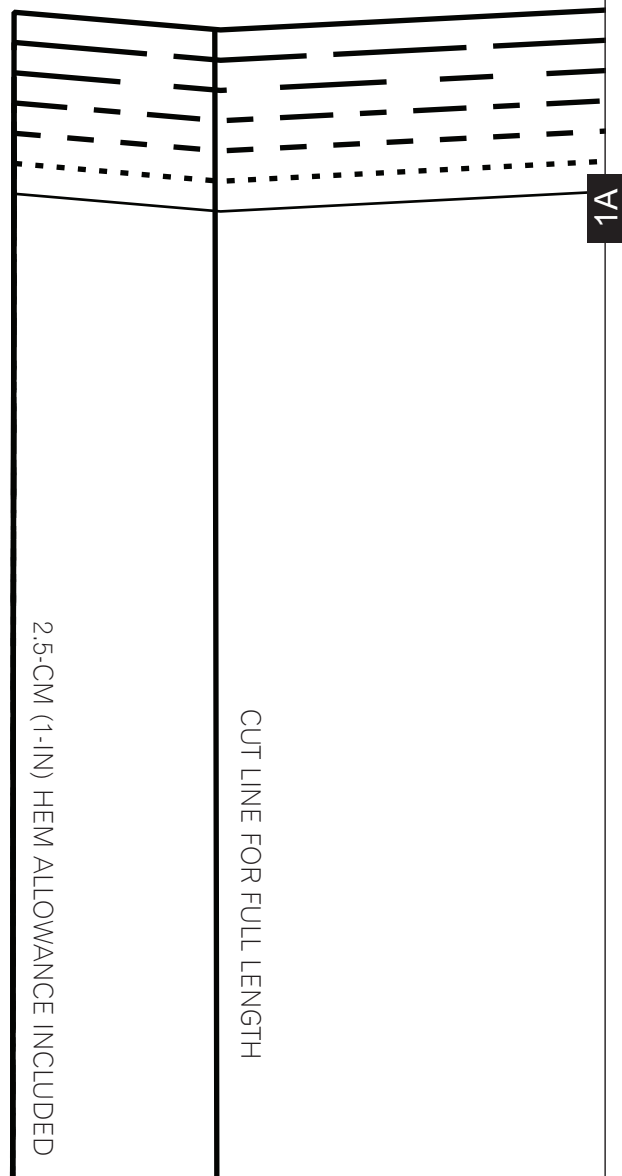

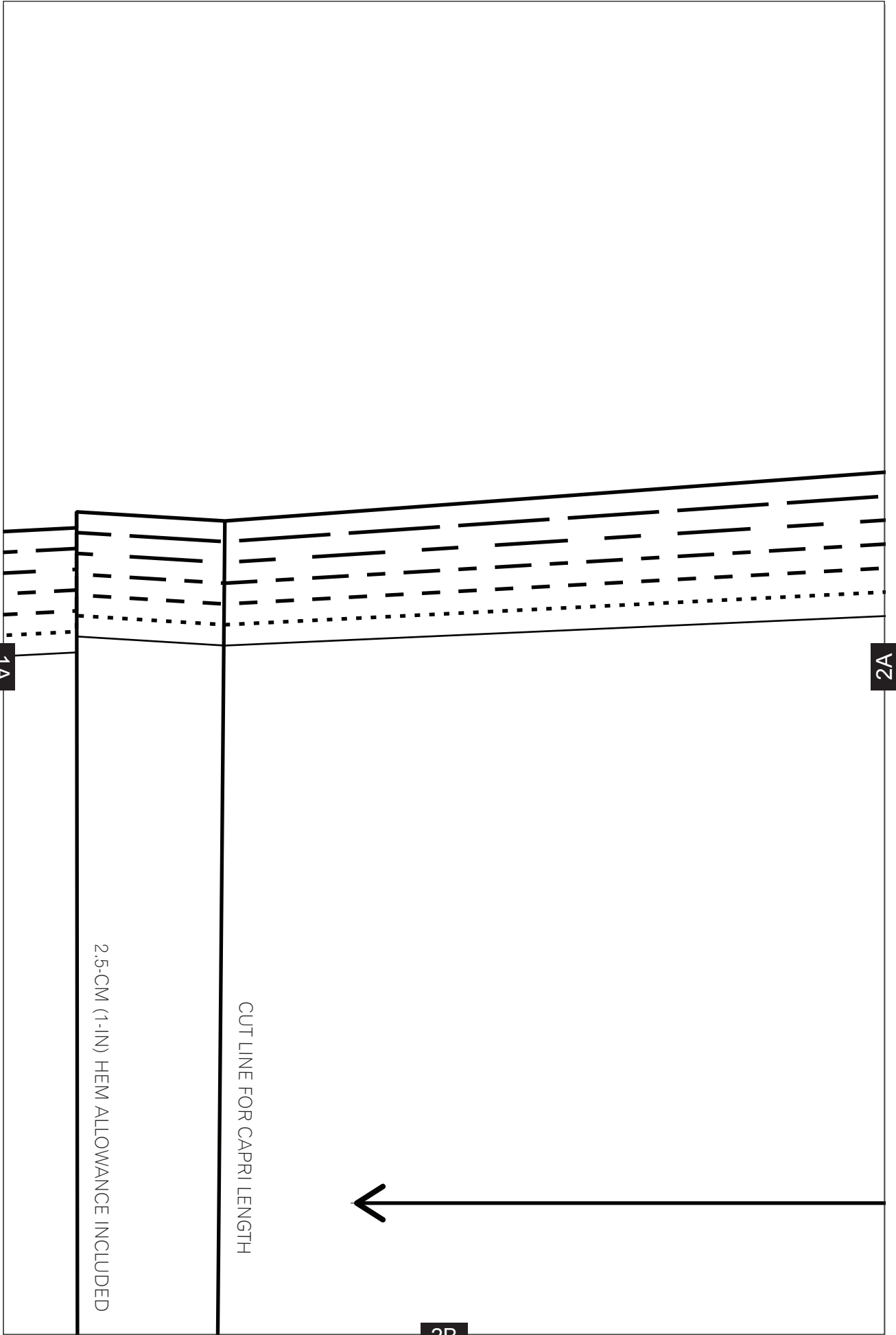

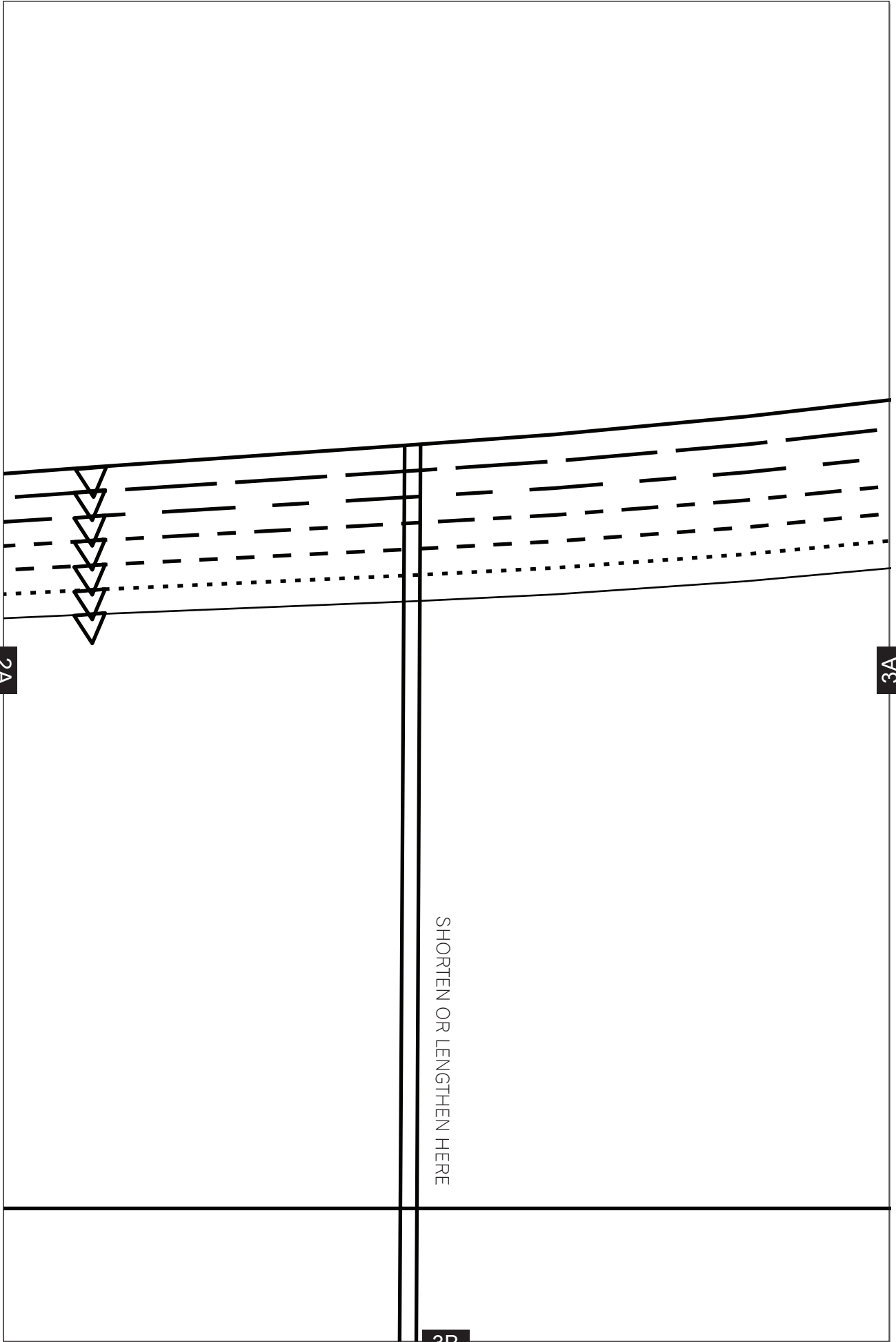

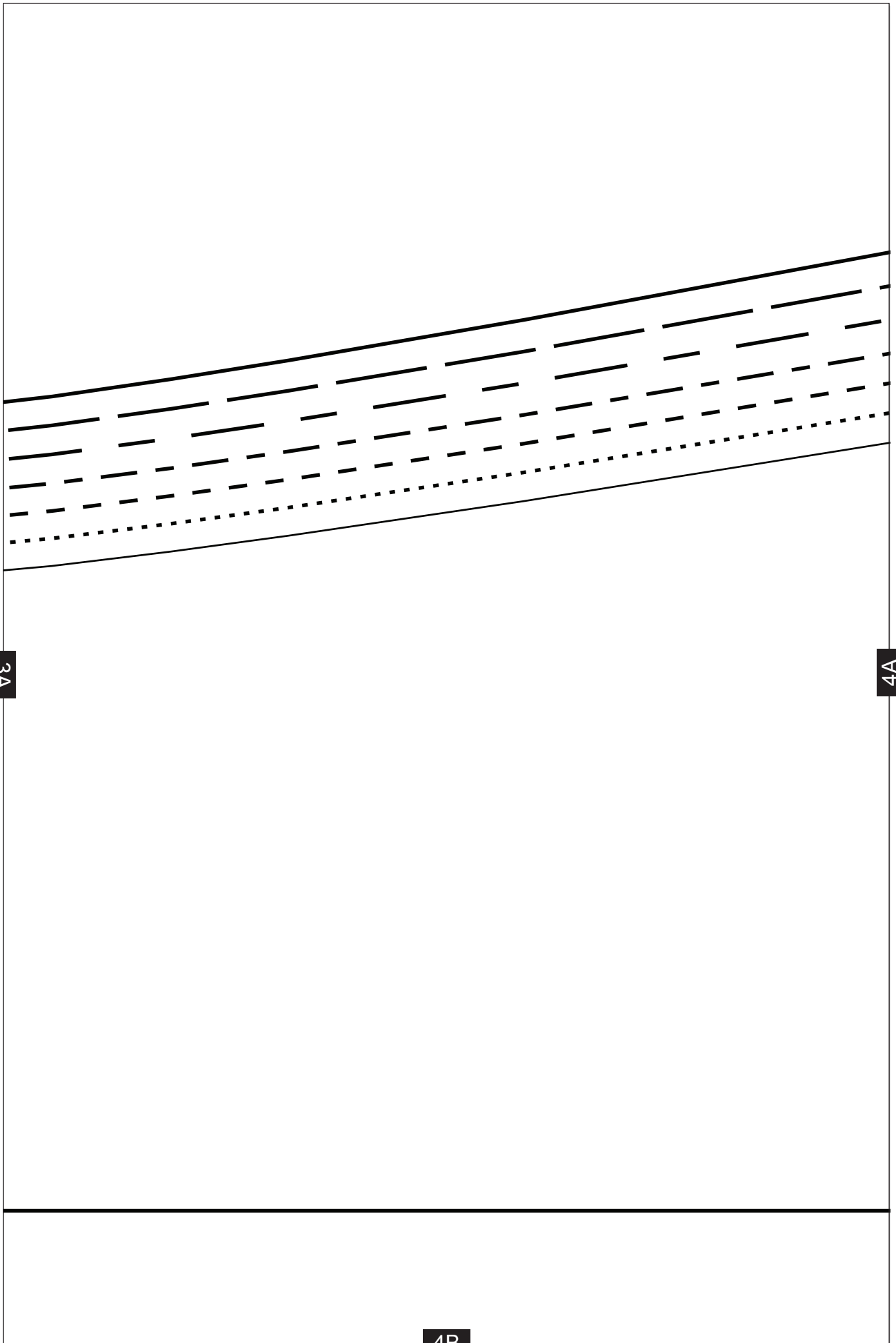

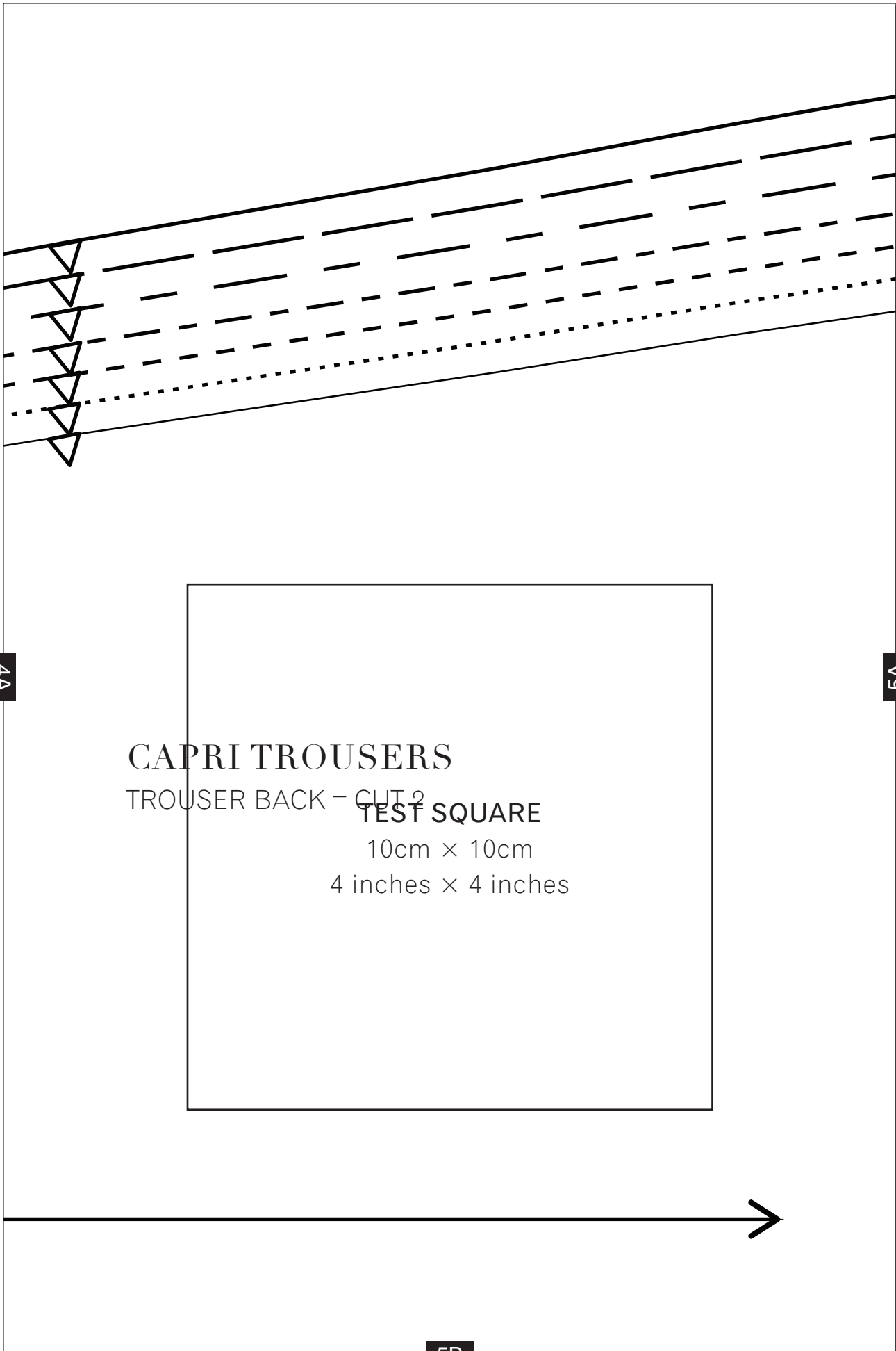

4A

5A

CAPRI TROUSERS

TROUSER BACK - CUT 2

TEST SQUARE

10cm x 10cm

4 inches x 4 inches

5B

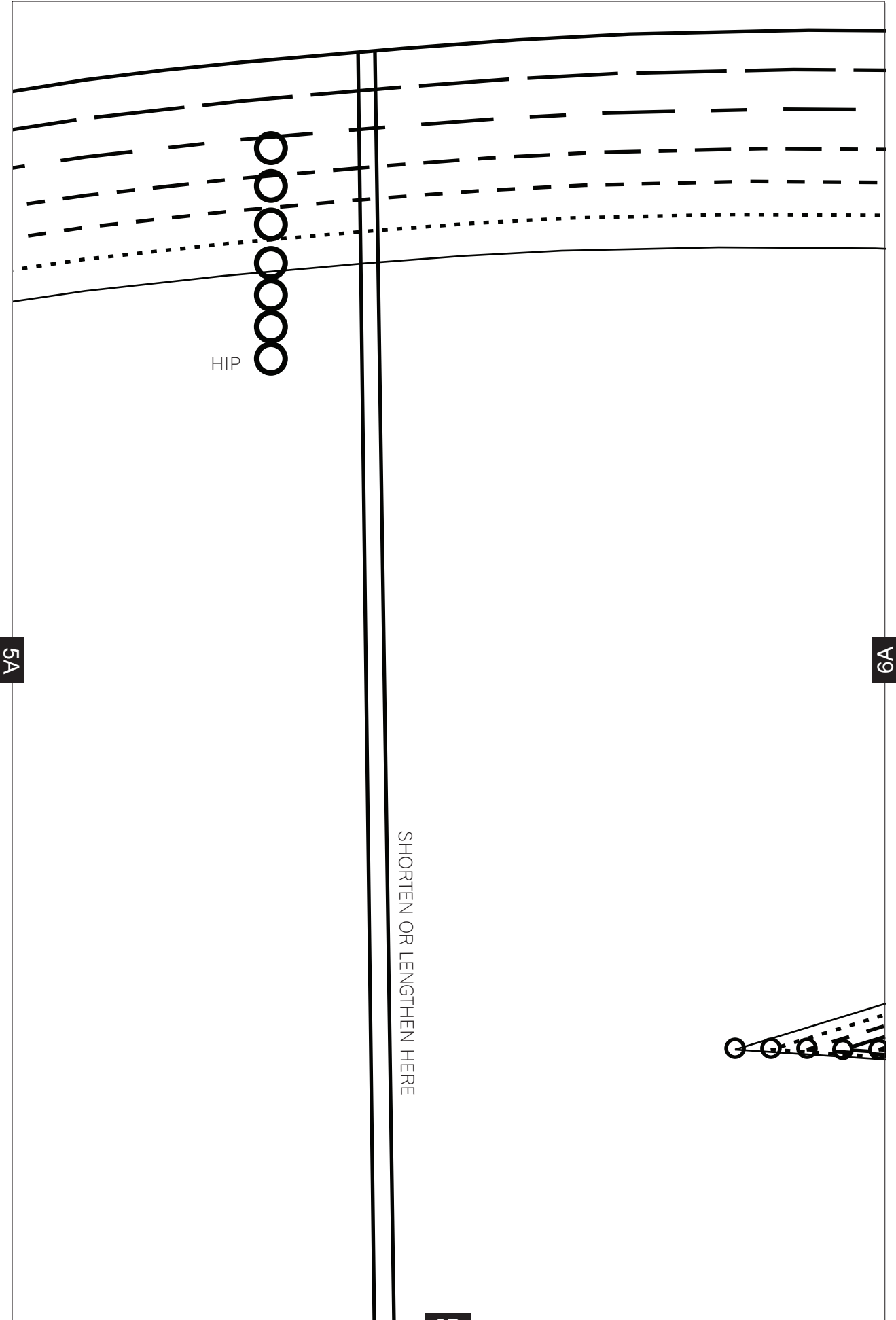

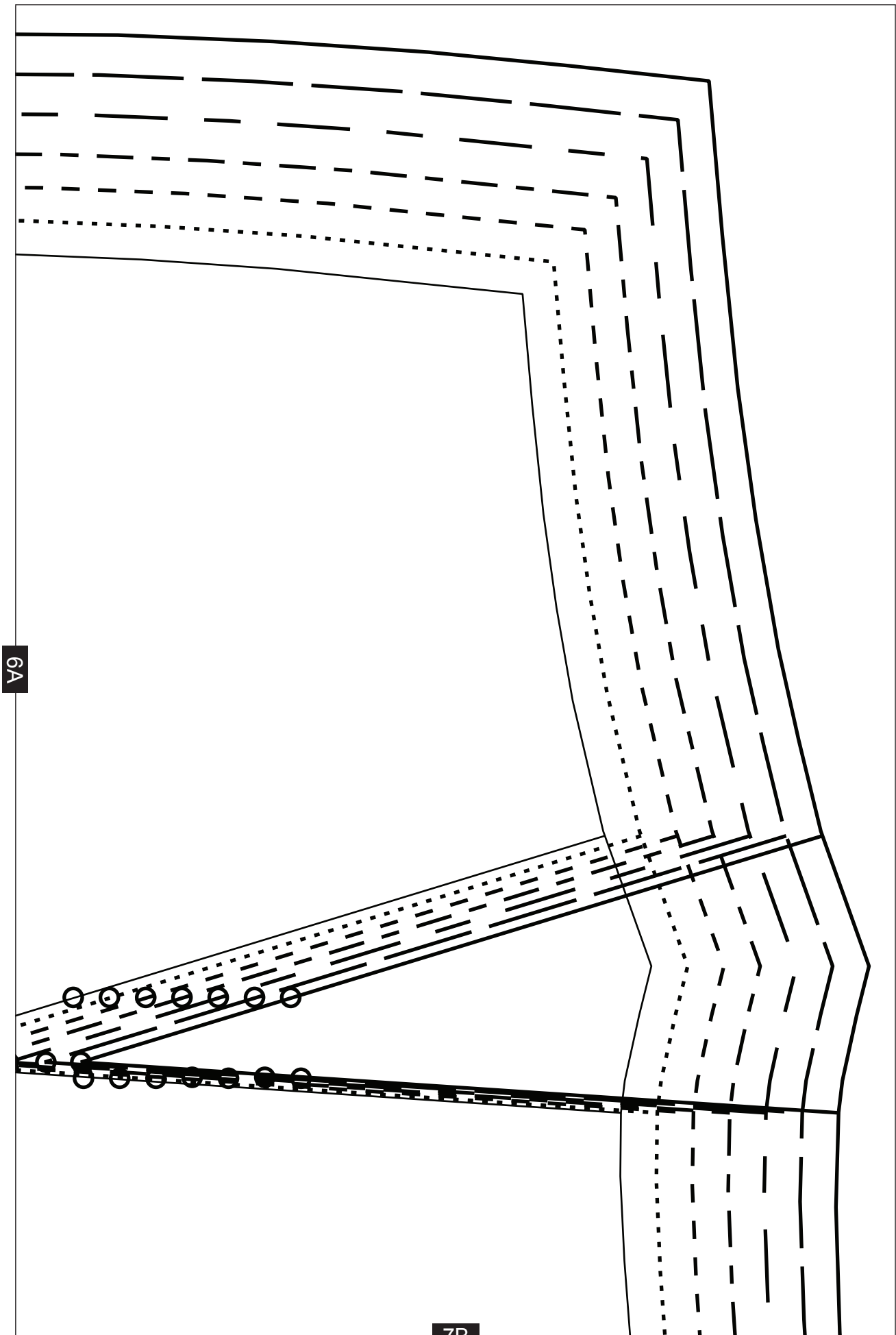

6A

7B

1B

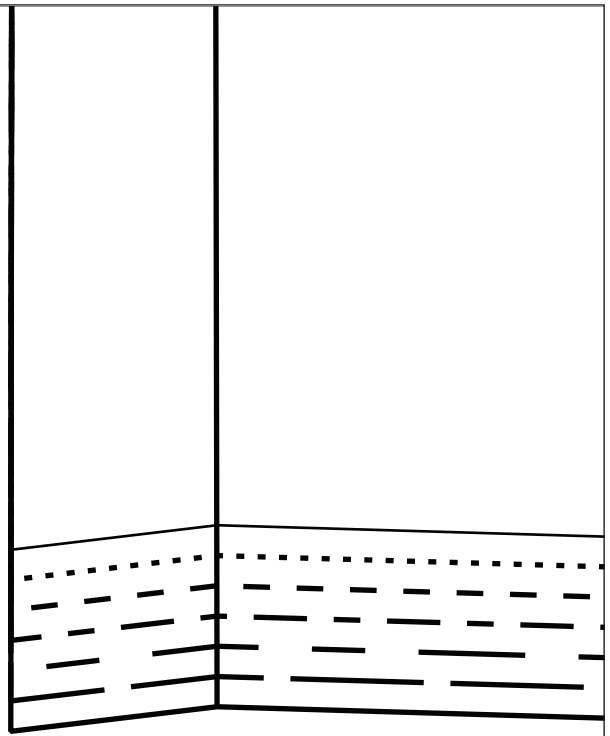

8A

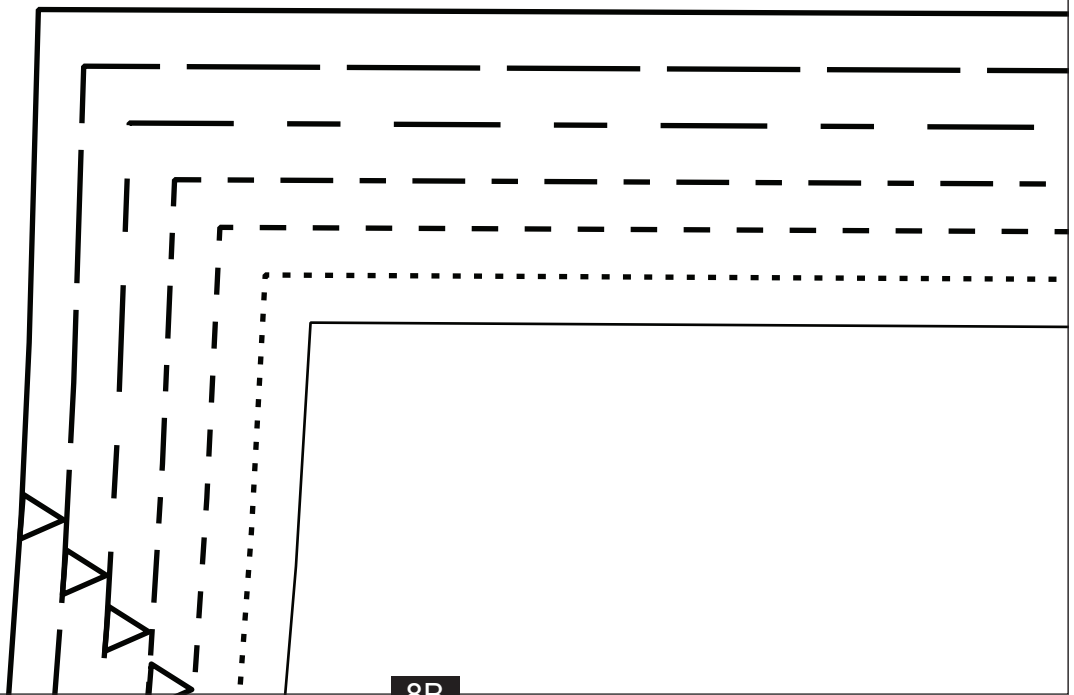

8B

2B

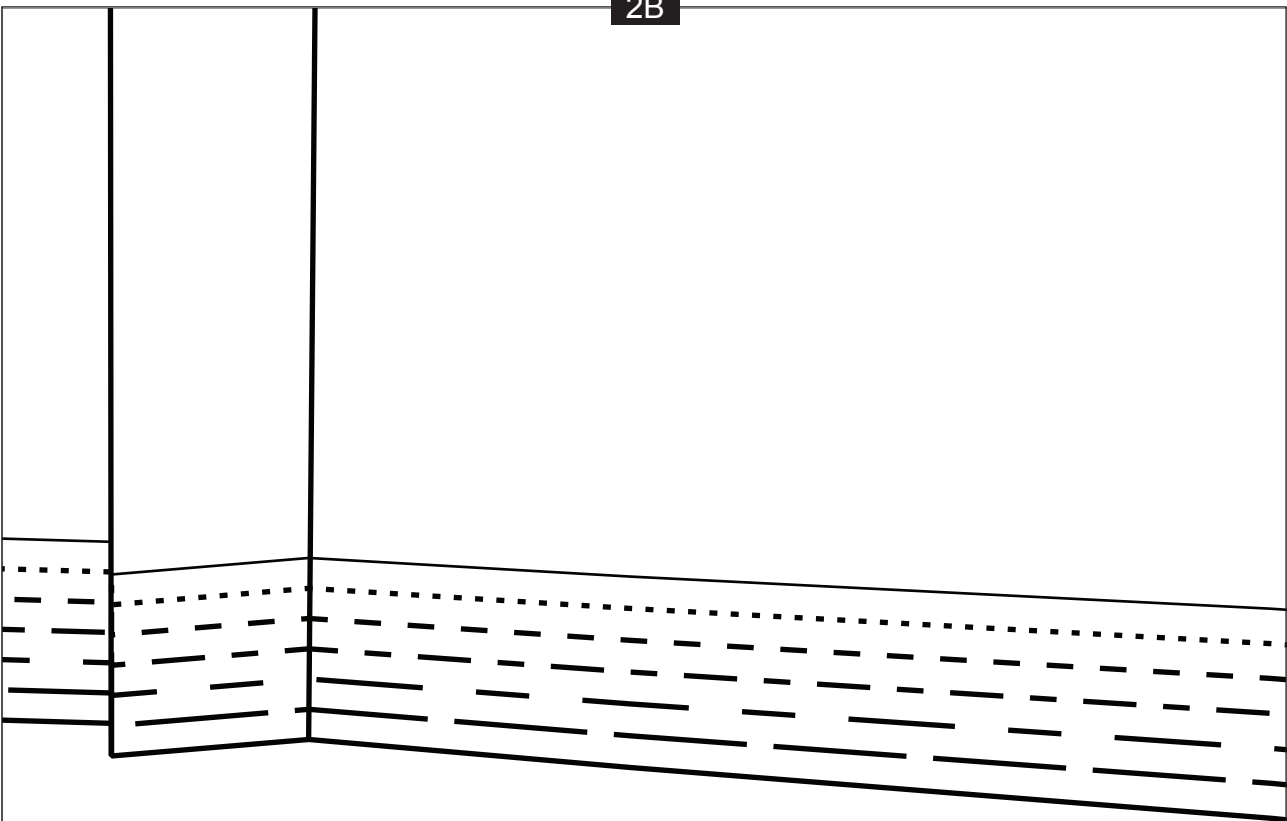

8A

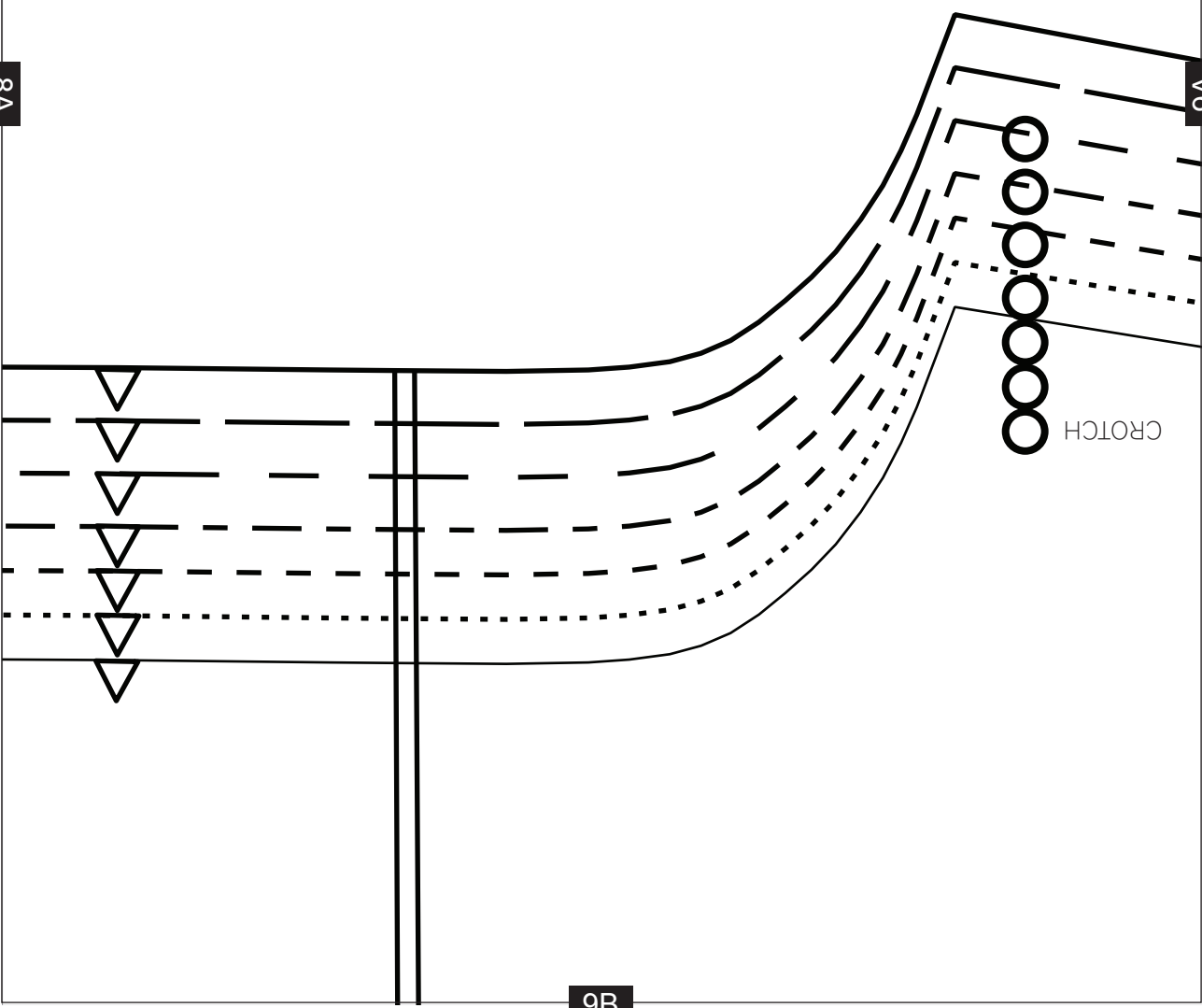

9A

9B

CROTCH

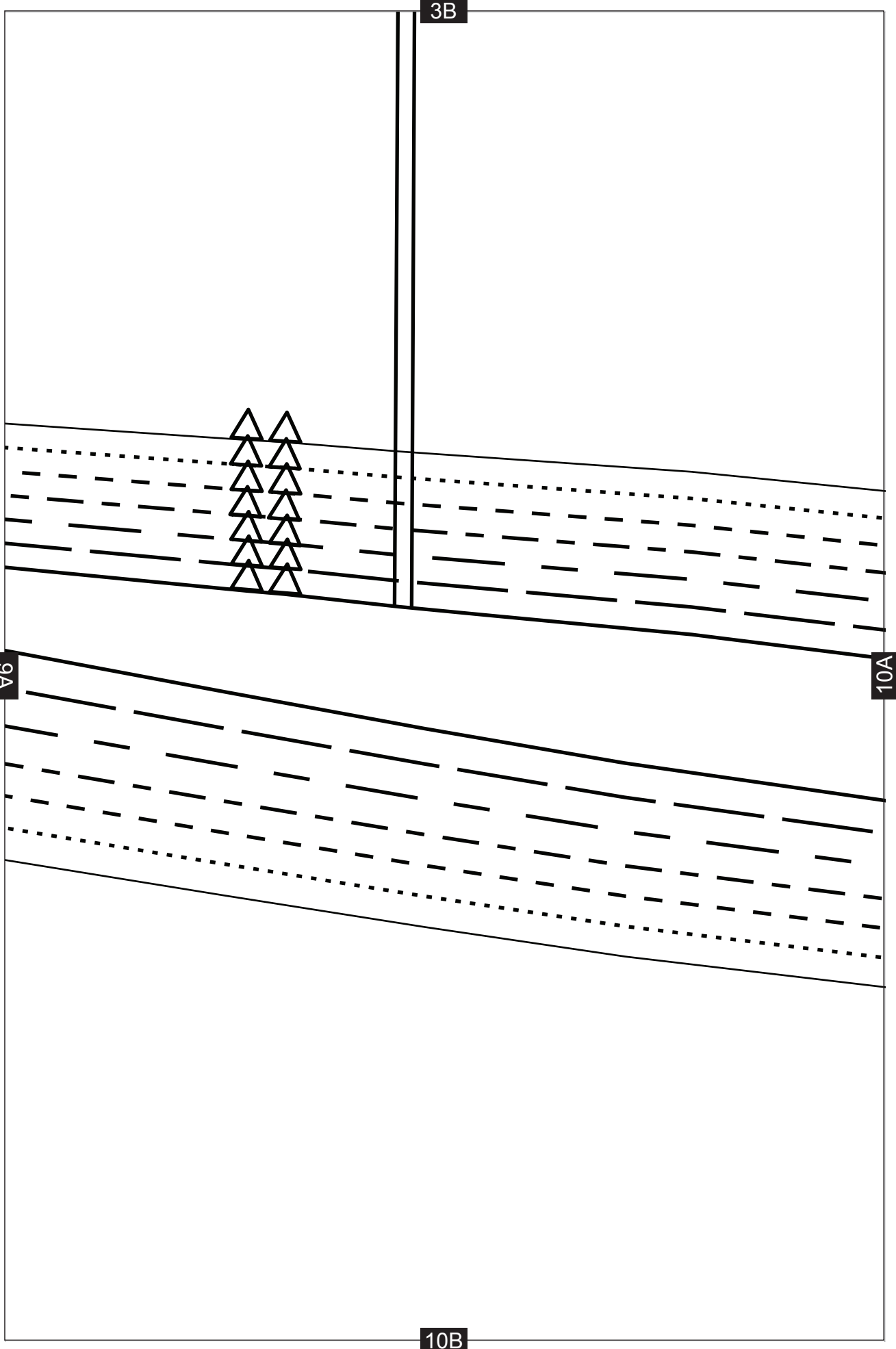

4B

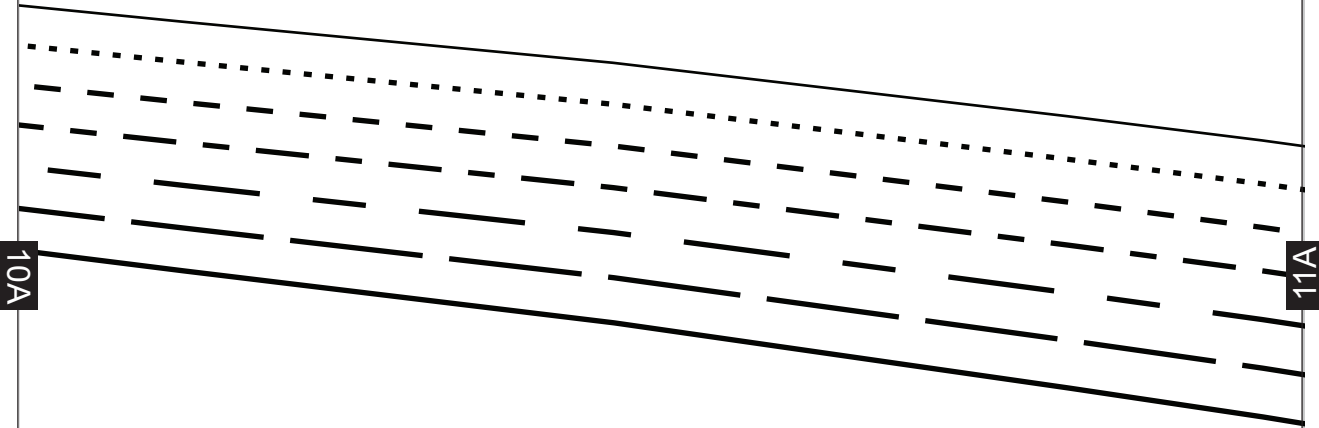

10A

11A

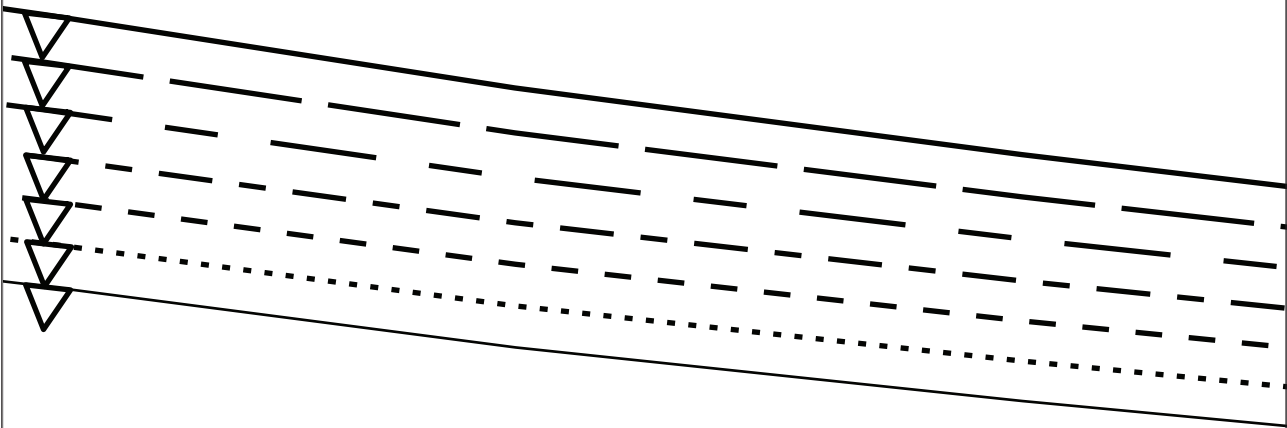

11B

5B

CROTCH

11A

12A

12B

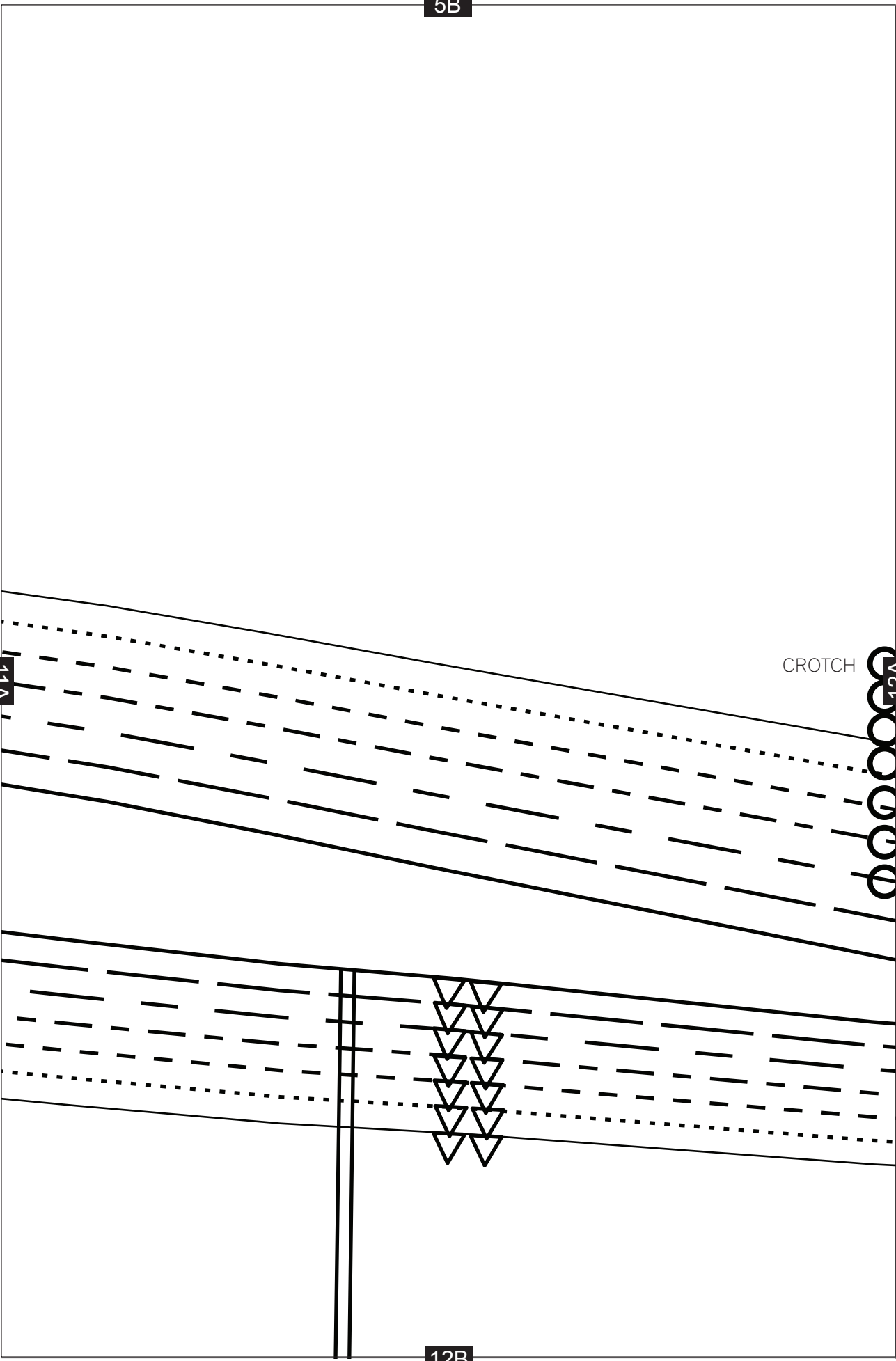

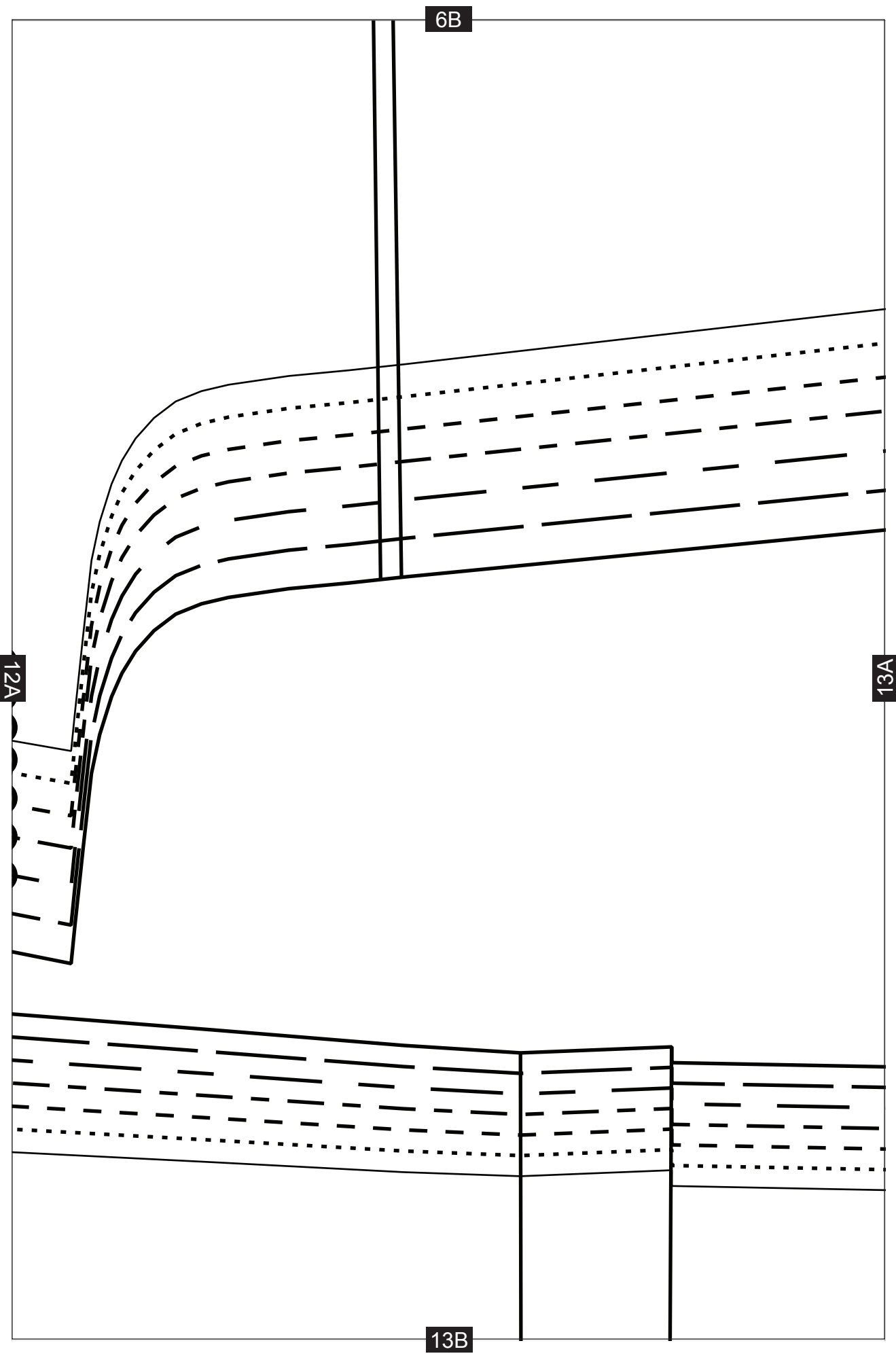

7B

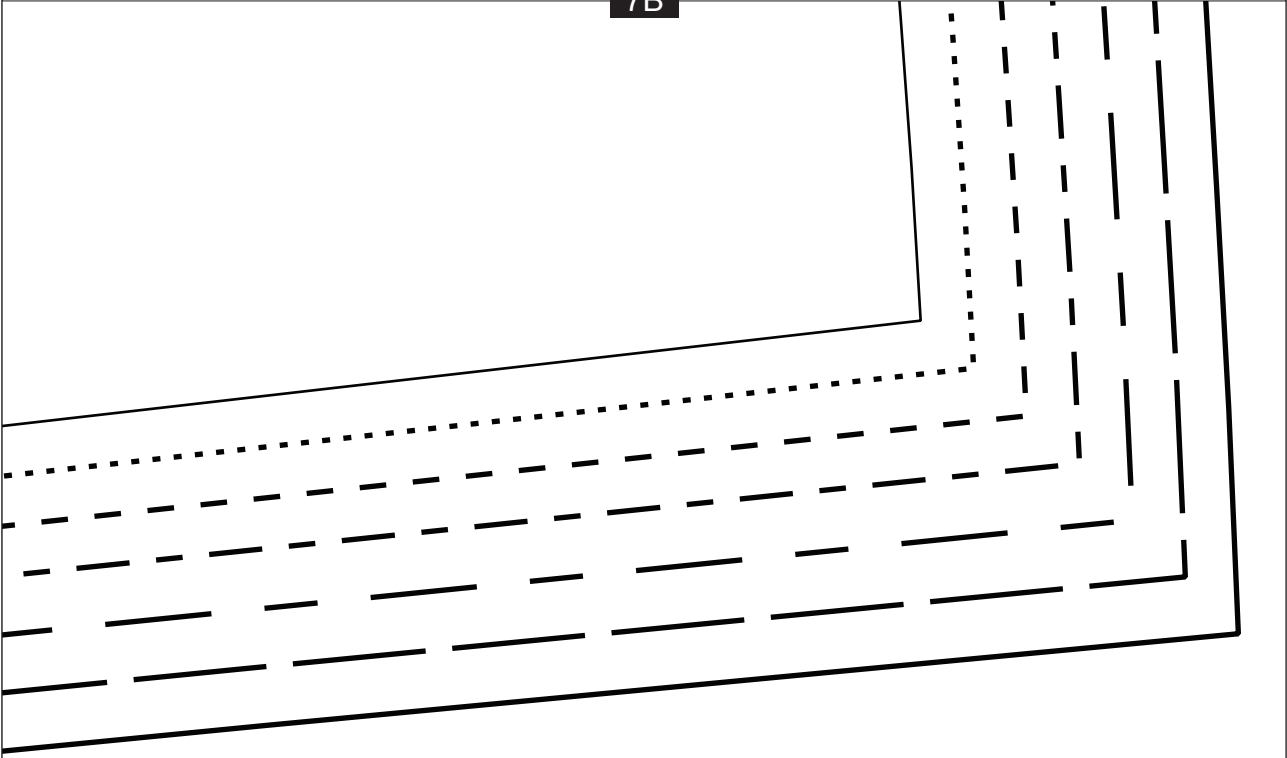

13A

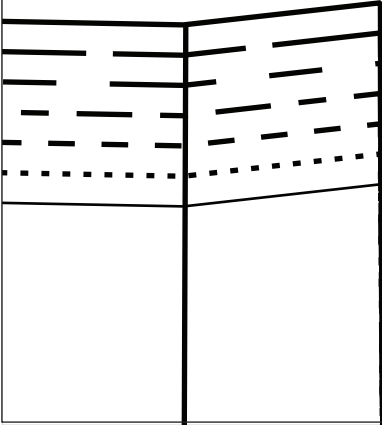

14B

8B

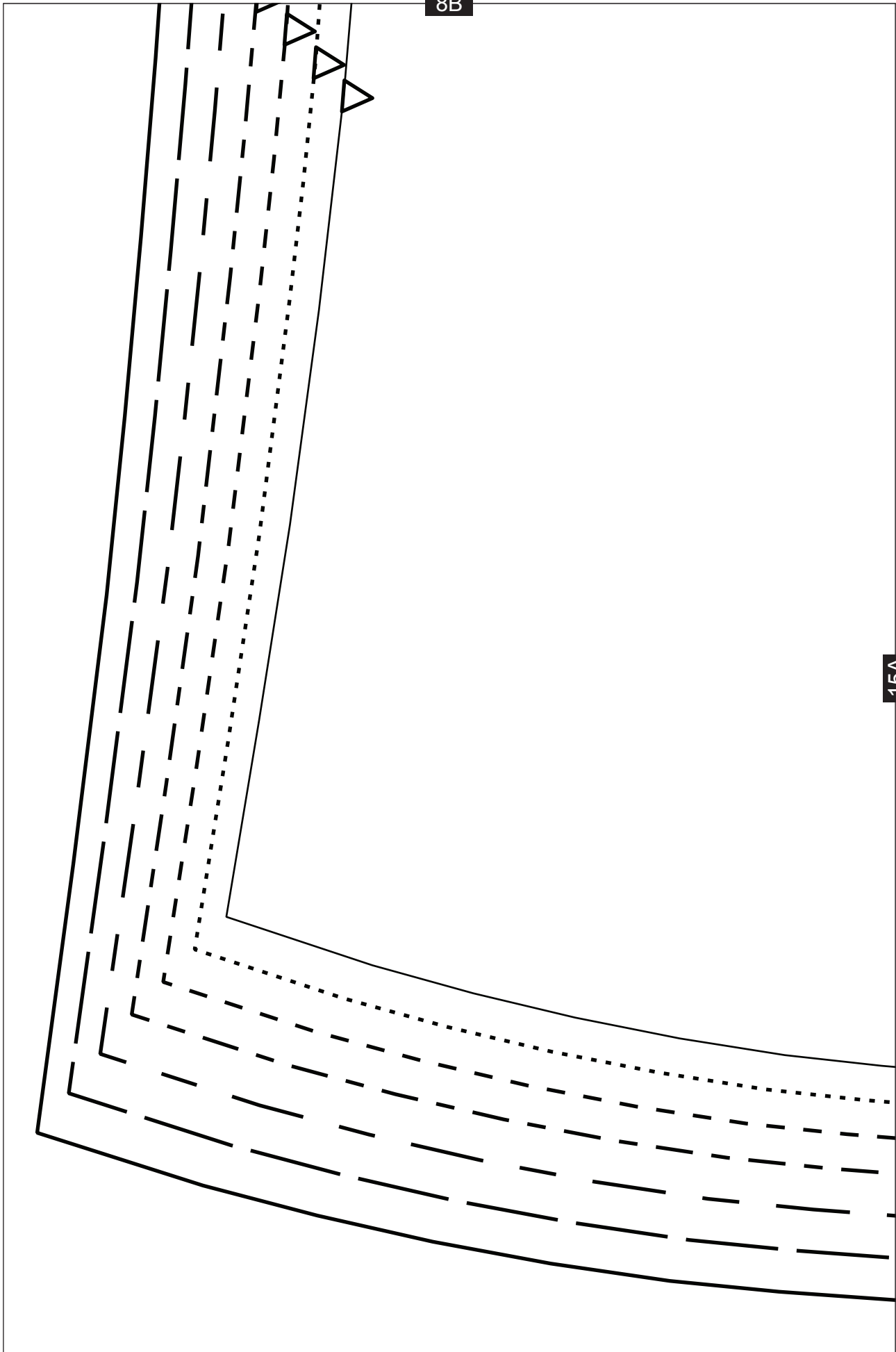

15A

15A

9B

16A

SHORTEN OR LENGTHEN HERE

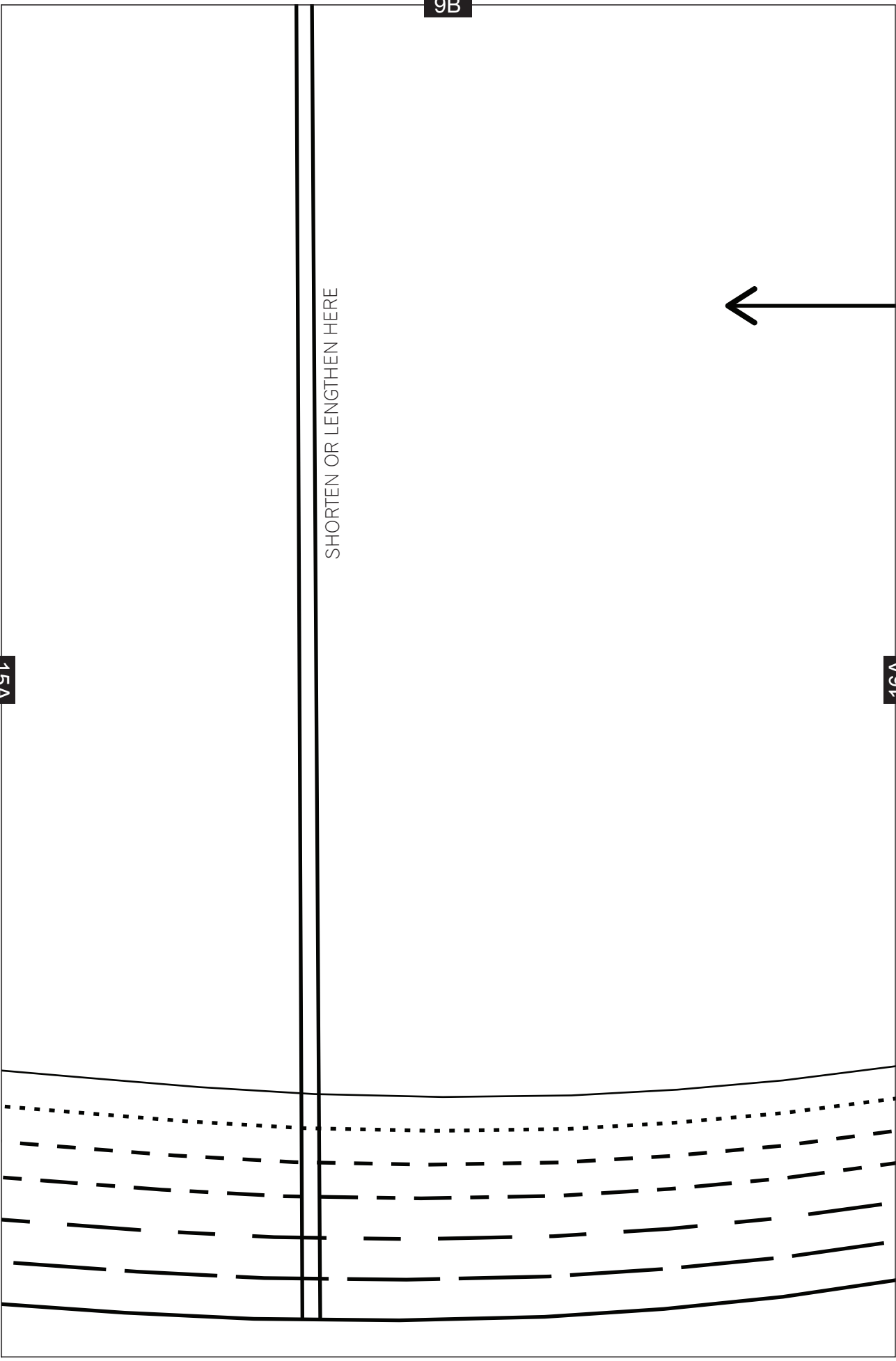

10B

CAPRI TROUSERS
TROUSER FRONT – CUT 2

16A

17A

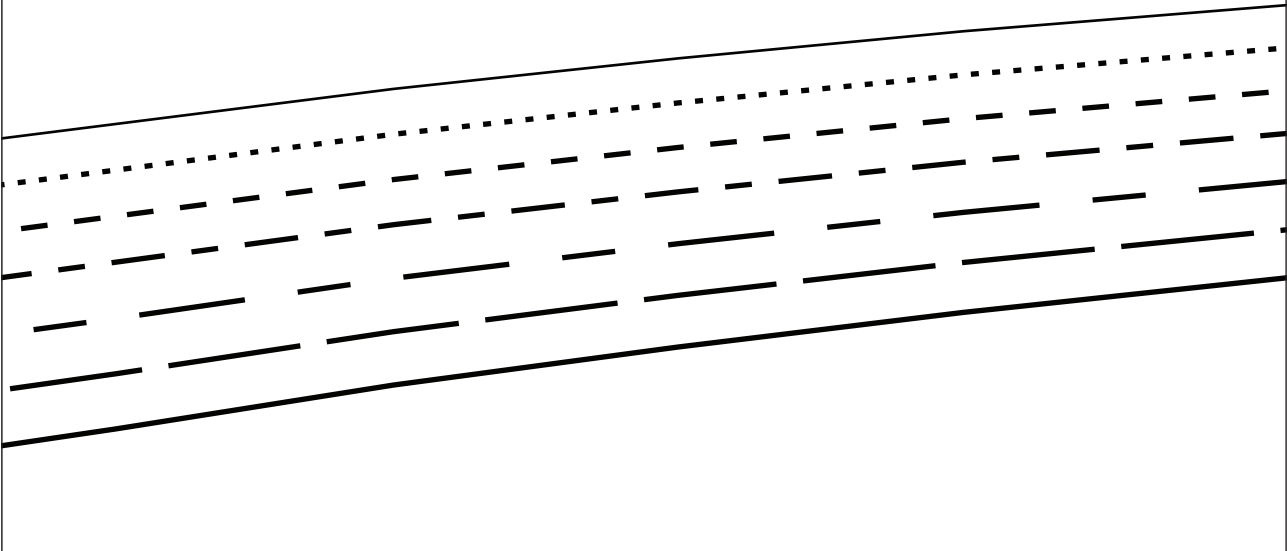

11B

17A

18A

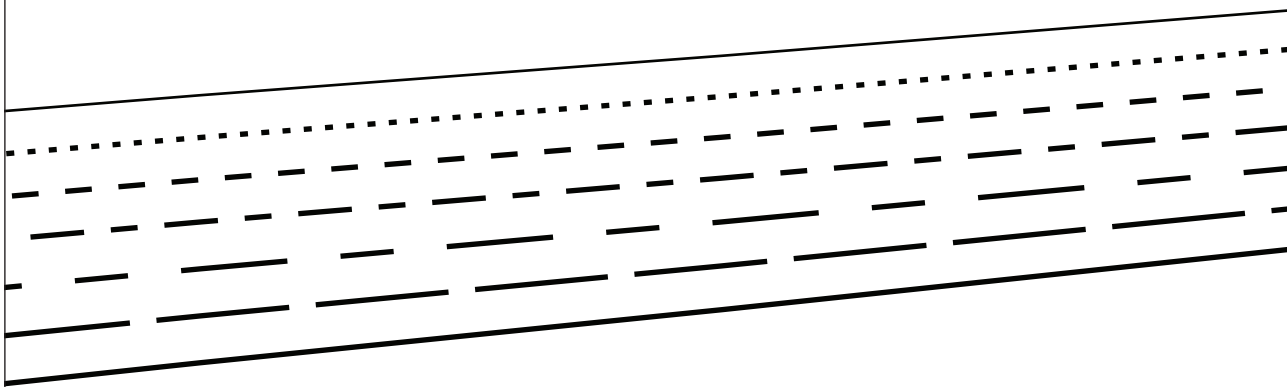

12B

18A

19A

SHORTEN OR LENGTHEN HERE

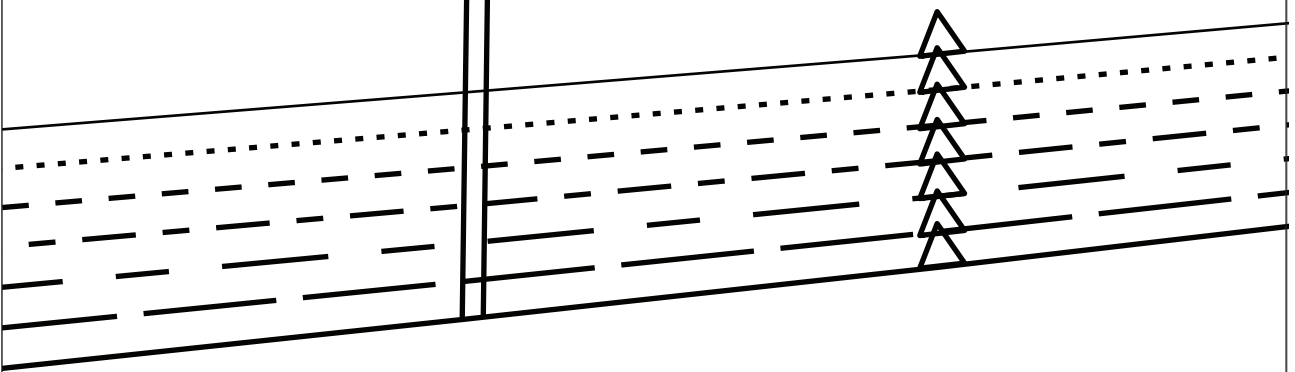

19A

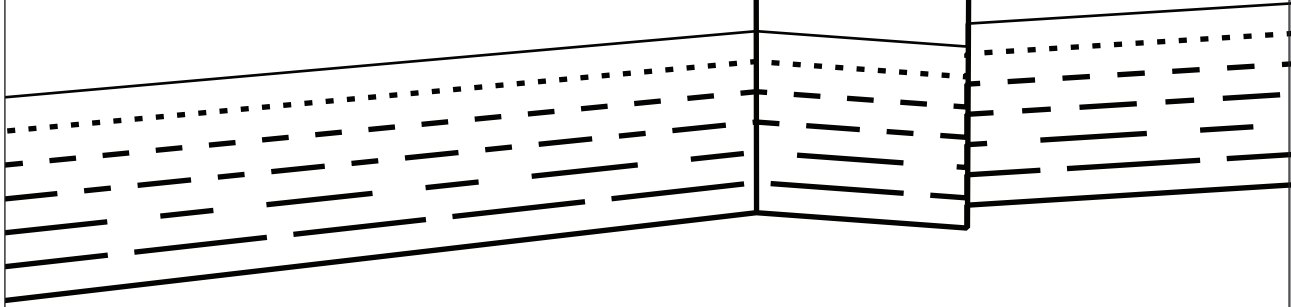

13B

CUT LINE FOR CAPRI LENGTH

2.5-CM 1(-IN) HEM ALLOWANCE INCLUDED

20A

20A

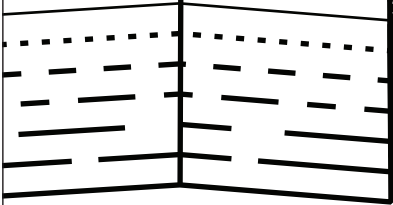

CUT LINE FOR FULL LENGTH

2.5-CM (1-IN) HEM ALLOWANCE INCLUDED

14B